



BOB® Trailers, Inc. (800) 893-2447 www.bobgear.com
13501 South Ridge Drive, Charlotte, North Carolina 28273

REVOLUTION® DUALLIE® SE, STROLLER STRIDES®

ENGLISH

Owner's Instruction Manual

TAKE TIME

READ AND UNDERSTAND THESE INSTRUCTIONS COMPLETELY!

Before attempting to assemble or use your new stroller, read and understand these assembly and use instructions completely, as well as the warnings at the beginning and throughout this document, to ensure proper assembly and operation.

**If you are unclear on any point, contact your dealer or BOB before use.
For a list of dealers, visit www.bobgear.com
or call (800) 893-2447.**





WARNINGS



FAILURE TO FOLLOW THESE WARNINGS AND ASSEMBLY INSTRUCTIONS COULD RESULT IN SERIOUS INJURY OR DEATH.

- Please save owner's manual for future use and reference.
- For safe operation, all users must read and understand instructions and warnings completely before use.
- Never leave children unattended in the stroller. Always keep children in view while in stroller.
- Avoid serious injury from falling or sliding out. Always use seat harnesses.
- Never allow occupants to stand in stroller. Stroller can tip over.
- Always use wrist strap to prevent being separated from stroller.
- Do not attach parcels or bags to the handlebar or frame of stroller except those recommended by BOB, as stroller can become unstable and tip over.
- Do not place sharp objects in the seat back pockets. Leaning against sharp objects in seat back pocket can result in injury to occupants.
- When starting out and during use, always make sure children's hands and feet are away from wheels.
- Do not use stroller on stairs or steep inclines. Stroller can tip over.
- Never use with low tire pressure or deflated tires as this could result in loss of control.
- Never pull stroller backward up stairs. Doing so could damage the suspension system, leading to frame failure.
- Use extreme caution when using stroller on uneven and/or unpaved, wet or slick surfaces, as these conditions create additional hazards and can lead to a loss of stability.
- Do not modify the stroller or any labels. Doing so voids the warranty and could lead to a dangerous condition.
- Protect stroller when transporting or shipping to prevent damage to stroller and stroller components. Check closely for damage after transporting or shipping.
- Discontinue using stroller if damaged or if any parts are missing.
- Do not wear roller skates or inline skates while pushing stroller.
- Care must be taken when folding and unfolding the stroller to prevent finger entrapment or injury.
- To avoid injuries, never fold or unfold stroller with other individuals within reach of stroller.
- The stroller is not equipped for use in low light or after dark.
- Failure to properly assemble or install the quick release wheels on this stroller may result in the wheels becoming detached while moving and a subsequent loss of control.
- Never jog with the stroller in walk mode because doing so could result in loss of control.
- The parking brake is not designed as a stopping brake. The brake should not be used to slow or stop the stroller because doing so could cause the stroller to stop abruptly, resulting in loss of control.
- Do not park on inclines. The parking brake is intended to park the stroller on flat surfaces only. Parking on inclines may result in tip over or runaway stroller.
- Never leave children in the stroller unattended with or without the parking brake set.
- Never load or unload the stroller without the parking brake set.
- The maximum weight capacity of the stroller is 100 lbs (45 kg) (occupants plus luggage weight). Maximum occupant height is 44 inches or (112 cm). Do not exceed the maximum weight or height, as stroller will become unstable.
- Always jog with the stroller seats in the fully upright position. Jogging with the seat/seats in reclined positions may result in a loss of stability.
- When seat/seats are fully reclined, backward tip over is more likely.

TABLE OF CONTENTS

WARNINGS	Page 2
TABLE OF CONTENTS	Page 3
STROLLER ANATOMY	Page 4
AGE RECOMMENDATIONS	Page 5
STROLLER ASSEMBLY	Page 5
Unpack Stroller	Page 5
Wheels	Page 5
Adjust Quick Release	Page 6
Rear Wheel Installation	Page 6
Removing Rear Wheel	Page 7
Front Wheel Secondary Retention Devices	Page 8
Front Wheel Installation	Page 8
Removing Front Wheel	Page 9
Unfold Stroller	Page 10
Fold Stroller	Page 10
STROLLER ADJUSTMENTS	Page 11
Choose Walk or Jog Mode	Page 11
Check Tire Pressure	Page 12
Adjust Tracking	Page 12
Fine Tune Tracking	Page 12
Select Shock Setting	Page 13
Setting Parking Brake	Page 13
Secure Child In Seat	Page 14
Attach Wrist Strap	Page 15
Recline Seat	Page 15
Position Canopy	Page 16
Accessory Adapter	Page 16
CARE AND MAINTENANCE	Page 16
STORAGE	Page 17
CARGO	Page 17
STROLLER ACCESSORIES	Page 17
LIMITED WARRANTY	Page 18

STROLLER ANATOMY

REVOLUTION DUALLIE STROLLER SE, STROLLER STRIDES

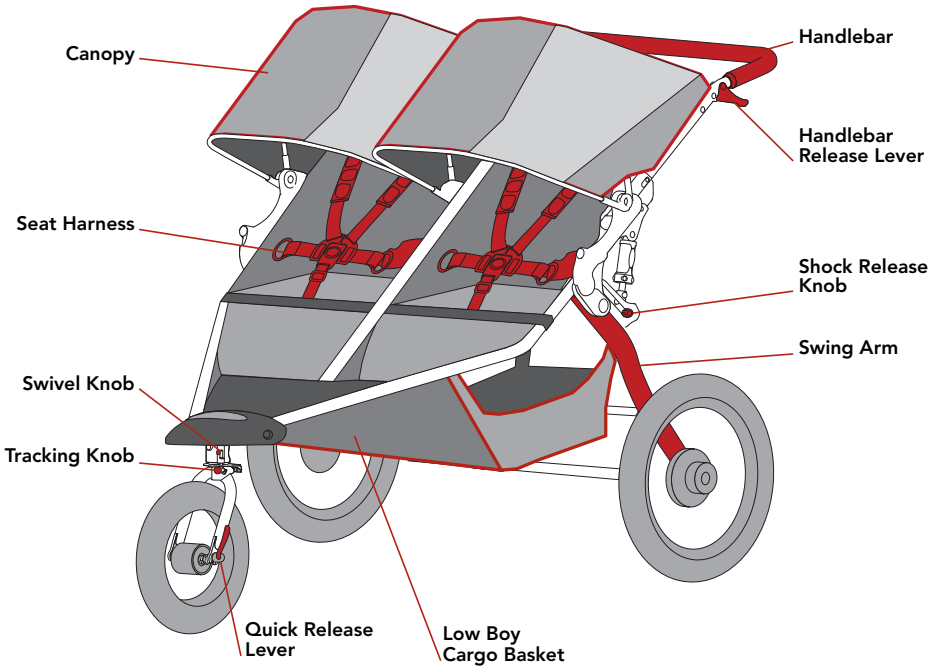

CONGRATULATIONS

Congratulations on your purchase of the BOB® Revolution® SE Duallie® or Stroller Strides Duallie®.

For updates to this manual, warranty and other recent product notifications, please visit www.bobgear.com periodically or any time before making approved changes or adding approved equipment to your stroller.

BOB recommends that you register your stroller at www.bobgear.com/register. This will allow us to notify you directly if there are any updates concerning the use of the stroller.

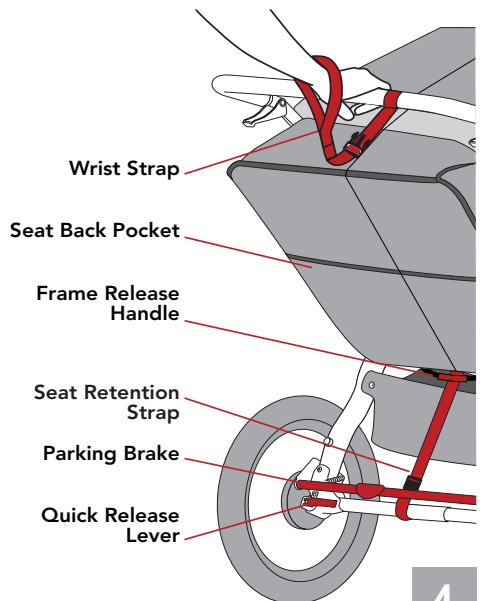

AGE RECOMMENDATIONS

BOB recommends that children should be at least 8 weeks old before riding in a BOB stroller without a BOB Infant Car Seat Adapter and compatible infant car seat. Please note that babies incapable of holding their head up must have additional head and neck support to ride safely and comfortably. For jogging or off-road stroller use, children should be at least 8 months old.

With the addition of the BOB Infant Car Seat Adapter and compatible infant car seat, newborns may be able to ride in the stroller. Children develop at different rates. Prior to first use, consult with your pediatrician regarding suitability of stroller use with your child.

Please refer to the below table for age/use guidelines:

RECOMMENDED USE	AGE
Infant Car Seat Adapter (Walk Only)	0 - 8 Weeks
See BOB Infant Car Seat Adapter Manual for maximum occupant weight.	
Walk Only	8 Weeks - 8 Months
Jogging/Off-Road	8 Months - 5 Years

STROLLER ASSEMBLY

UNPACK STROLLER

Remove stroller and wheels from box.

▲ WARNING Remove all packaging materials and discard to avoid choking and suffocation hazards.

WHEELS

Before attempting to install wheels, read and understand warnings and instructions completely.

▲ WARNING Using your stroller with an improperly adjusted wheel quick release can allow the wheel to vibrate, wobble or become detached from the stroller. This can result in serious injury or death. Accordingly, it is critical that you:

- Ask your dealer to instruct you on the proper technique for safely installing and removing your wheels.
- Understand and use the proper method for securely clamping a wheel to the stroller using a quick release.
- Check to make sure the wheels are securely clamped before each use of the stroller.

The wheel quick release is a cam device that supplies the clamping force required to hold the stroller wheel securely in place. To safely secure a wheel to the stroller, it is critical that you understand how the quick release works, how to use and adjust it properly and the amount of force necessary to safely secure the wheel.

▲ WARNING The quick release is a cam device and must be used correctly to supply the necessary clamping force to safely hold the wheel in place. It is not a wing nut system and turning the lever while holding the tension adjusting nut does not supply the required force to safely clamp the wheel in the dropouts.

ADJUST QUICK RELEASE

The rear wheels are correctly clamped in place by the force generated when the quick release lever is closed and the cam action pulls the axle against the dropout, securing it in place.

The front wheel is correctly clamped in place by the force generated when the quick release lever is closed and the cam action pulls the lever housing against one dropout, and pulls the adjusting nut against the other dropout, clamping the hub between the dropouts.

The tension adjusting nut sets the amount of clamping force. Turning the tension adjusting nut in the clockwise direction while preventing the quick release lever from rotating, increases the amount of clamping force. Alternatively, turning the tension adjusting nut counterclockwise, while preventing the quick release lever from rotating, reduces the amount of clamping force. The tension adjusting nut only needs minor adjustments to provide the correct clamping force, less than a half turn can mean the difference between safe and unsafe clamping force.

REAR WHEEL INSTALLATION

1. Unlock Parking Brake

Prior to installing the rear wheels, position the parking brake in the unlocked position.

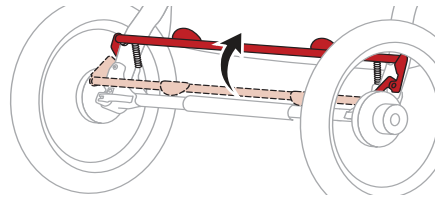

2. Rotate Quick Release Lever

Rotate the quick release lever so it curves away from the dropout.

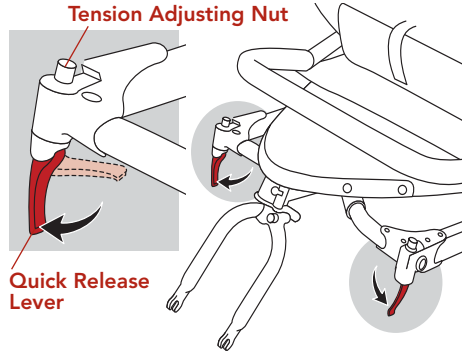

3. Insert Rear Wheel Stub Axle

Insert the rear wheel's stub axle into the hole in the rear dropout. If the axle does not slide in easily, loosen the quick release tension adjusting nut by hand. Re-insert the axle fully into the rear dropout until the axle shoulder or snap ring on the axle comes in contact with the dropout.

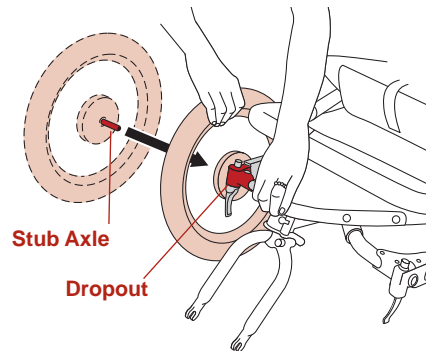

4. Adjust Quick Release Cam Lever

To adjust the quick release, hold the quick release cam lever in the FULLY OPEN position with your right hand, and tighten the tension adjusting nut with your left hand until it is finger tight against the dropout.

To TIGHTEN tension adjusting nut, turn clockwise.

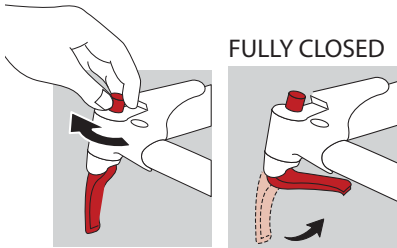

To properly close the quick release and secure the rear wheel in the dropouts, confirm the axle is fully inserted in the dropout, while maintaining the wheel in this position, rotate the quick release toward stroller and into the FULLY CLOSED position.

When properly closed, the curve of the quick release will be pointing toward the dropout and angled slightly toward the center of the stroller. To generate enough clamping force it is necessary to wrap your fingers around the dropout while closing the quick release lever. The proper force required to close the quick release lever should leave a visible imprint in the palm of your hand.

▲ WARNING It takes considerable force to securely clamp the wheel. If you are able to completely close the quick release without wrapping your fingers around the dropout and the quick release lever does not leave a visible imprint in the palm of your hand, the tension is not adequate.

Rotate the lever to the FULLY OPEN position and turn the tension adjusting nut a quarter turn clockwise and repeat the closing process.

If the quick release lever cannot be rotated to the FULLY CLOSED position, rotate the lever to the FULLY OPEN position and turn the tension adjusting nut a quarter turn counterclockwise. Repeat the closing process.

To LOOSEN tension adjusting nut, turn counterclockwise.

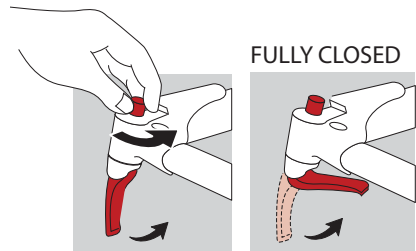

REMOVING REAR WHEEL

1. Unlock Parking Brake

Prior to removing the rear wheels, position the parking brake in the unlocked position.

2. Open Quick Release Lever

Move the wheel's quick release lever from the locked or FULLY CLOSED position to the FULLY OPEN position.

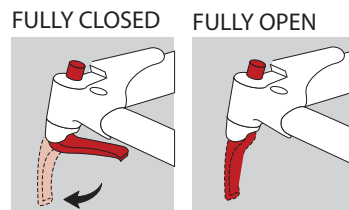

3. Remove Wheel

Raise the wheel a few inches off the ground and pull the wheel out of the dropout.

FRONT WHEEL SECONDARY RETENTION DEVICES

Your stroller fork utilizes secondary wheel retention devices designed to help keep the wheel from disengaging from the fork if the quick release is incorrectly adjusted and tightened. The wheel can still remain loose and wobbly even with the secondary retention device working if the quick release has not been properly tightened and adjusted. The secondary retention devices are backup systems and are not intended as a substitute for a properly adjusted quick release. The secondary retention devices on your stroller are the integral type that are formed into the outer faces of the fork dropouts.

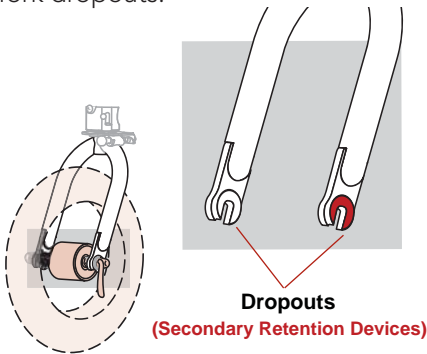

⚠ WARNING It is critical that you do not remove or disable the secondary retention devices. The secondary retention devices serve as a backup for a critical adjustment. The secondary retention devices can reduce the risk of the wheel disengaging from the fork if the quick release is not adjusted and tightened correctly. Removing or disabling the secondary retention devices will void the warranty.

Secondary retention devices are not a substitute for correct quick release adjustment and tightening. Using your stroller with an improperly adjusted and tightened wheel quick release can allow the wheel to vibrate, wobble or become detached from the stroller. This can result in serious injury or death.

FRONT WHEEL INSTALLATION

1. Rotate Quick Release Lever
Rotate quick release lever so that it curves away from the wheel. This places it in the FULLY OPEN position.

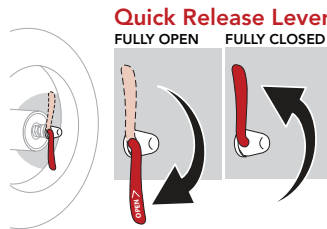

2. Insert Front Wheel
When facing the front of the stroller, insert the wheel between the fork dropouts so that the axle firmly contacts the top of the slots of the fork dropouts.

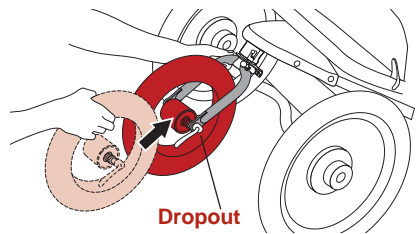

3. Adjust Quick Release Lever
To adjust the quick release, hold the quick release cam lever in the FULLY OPEN position with your right hand as shown. Tighten the tension

adjusting nut with your left hand until it is finger tight against the fork dropout.

Tension Adjusting Nut

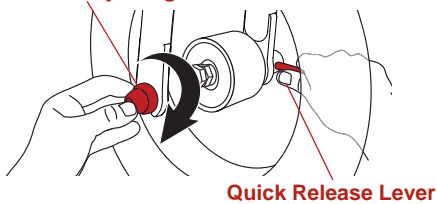

4. Close Quick Release Lever

To properly close the quick release and secure the front wheel in the dropouts, confirm the axle is contacting the top of the dropouts on both sides and the wheel is centered left to right.

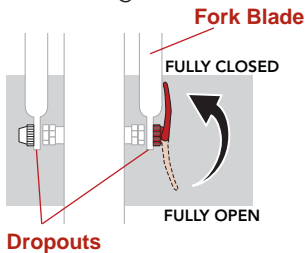

While maintaining the wheel in this position, rotate the quick release upward and into the FULLY CLOSED position. When properly closed, the curve of the quick release will be pointing toward the wheel and parallel to the fork blade. To generate enough clamping force it is necessary to wrap your fingers around the fork blade while closing the quick release lever. The proper force required to close the quick release lever should leave a visible imprint in the palm of your hand.

▲ WARNING It takes considerable force to securely clamp the wheel. If you are able to completely close the quick release without wrapping your fingers

around the fork blade and the quick release lever does not leave a visible imprint in the palm of your hand, the tension is not adequate. Rotate the lever to the FULLY OPEN position and turn the tension adjusting nut a quarter turn clockwise and repeat the closing process.

If the quick release lever cannot be rotated to the FULLY CLOSED position, rotate the lever to the FULLY OPEN position and turn the tension adjusting nut a quarter turn counterclockwise. Repeat the closing process.

REMOVING FRONT WHEEL

1. Open Quick Release Lever

Move the wheel's quick release lever from the locked or FULLY CLOSED position to the FULLY OPEN position. Your front fork has integral secondary retention devices that require loosening the tension adjusting nut enough to allow removal of the wheel.

2. Remove Front Wheel

Raise the front wheel a few inches off the ground and tap the top of the wheel with the palm of your hand to knock the wheel out of the front fork.

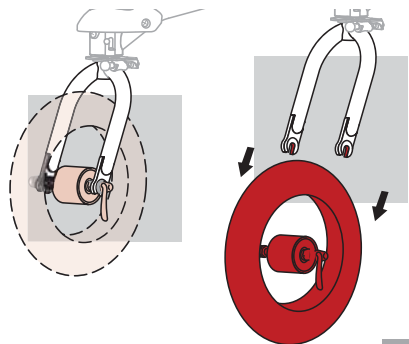

UNFOLD STROLLER

▲ WARNING Care must be taken when folding and unfolding the stroller to prevent finger entrapment or injury.

▲ WARNING To avoid injuries, never fold or unfold stroller with other individuals within reach of stroller.

1. Lift Red Frame Release Handle

Keep tires on ground as stroller swing arm begins to swing open.

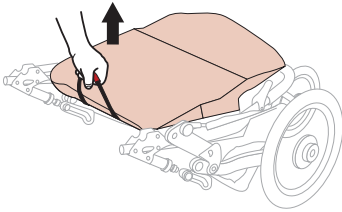

NOTE: Stroller swing arm will swing open and “snap” into an open and locked position.

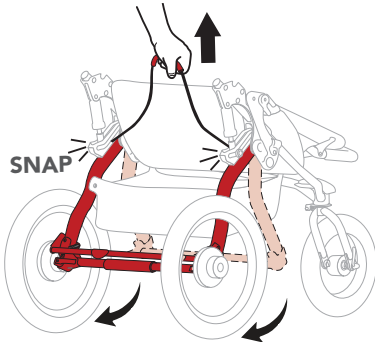

2. Rotate Handlebar

Lift handlebar up and back until it “snaps” into locked and upright position.

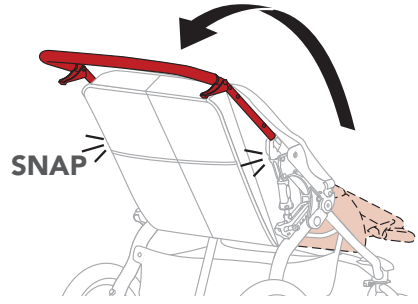

3. Attach Seat Retention Strap

Loop seat retention strap around cross tube and secure with buckle.

▲ WARNING Do not loop seat retention strap around or over brake bar.

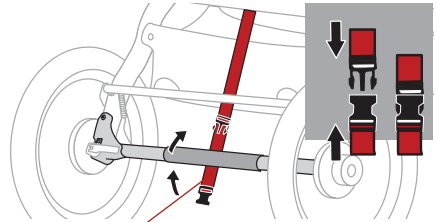

Un-Attached Seat Retention Strap

▲ WARNING Seat retention strap must be correctly attached before loading stroller.

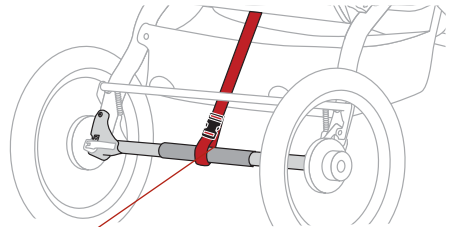

Correctly Attached Seat Retention Strap

FOLD STROLLER

1. Lock Parking Brake

Set parking brake in locked position.

2. Remove Children From Seats

3. Empty Stroller

Remove contents from low boy cargo basket and pockets.

4. Unbuckle Seat Retention Strap

5. Rotate Handlebar

Squeeze both handlebar release levers simultaneously. Rotate handlebar forward onto seat.

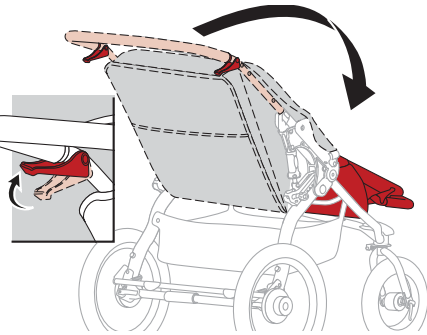

6. Lift Red Frame Release Handle

Using a short, quick tug, lift red frame release handle up. Keep tires on ground as stroller collapses toward front wheel.

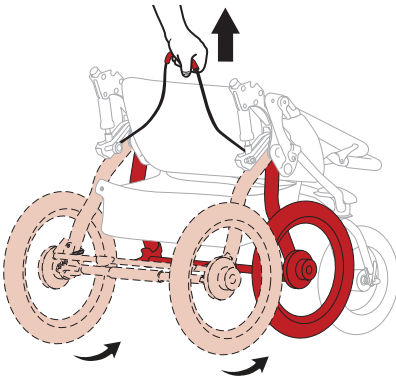

7. Lay Stroller Flat

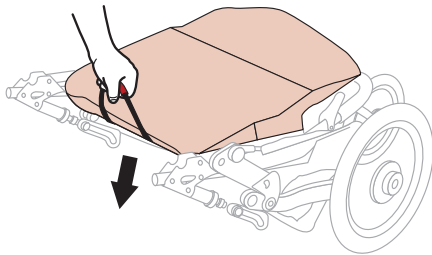

8. Secure Folded Stroller

Use wrist strap buckle to secure stroller in folded position.

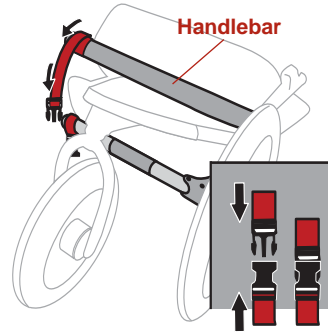

9. Make It Smaller

Take off the front and rear wheels to make it even smaller. See Removing Rear Wheel and Removing Front Wheel sections.

STROLLER ADJUSTMENTS

CHOOSE WALK OR JOG MODE

If front fork is in "JOG MODE" front fork will be locked and the front fork/wheel will not swivel left or right as it does in "WALK MODE".

▲ WARNING Never jog with the stroller in walk mode. Doing so could result in loss of control and serious injury.

WALK MODE (Walking)

Slide swivel knob up and to the left. Fork will now rotate 360 degrees.

NOTE: Stroller is shipped with front wheel in walk mode.

JOG MODE (Jogging/Off-Road)

Slide swivel knob upward and to the right. Knob will slide into downward position. Rotate fork/wheel until it "snaps" into forward position.

WALK MODE

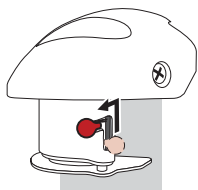

JOG MODE

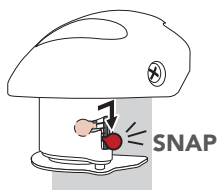

CHECK TIRE PRESSURE

Plastic wheels are rated to a maximum tire inflation pressure of 30 pounds per square inch (psi). The maximum inflation pressure is embossed on the wheel next to the valve stem.

▲ WARNING Inflating tires above 30 psi can damage the wheel and/or tire resulting in loss of control and injury.

Aluminum wheels can have the tires inflated to the pressure embossed on the tire. However, we recommend 30 psi for a comfortable ride.

▲ WARNING Inflating tires above the maximum inflation pressure embossed on the tire can damage rim and or tire resulting in loss of control and injury.

ADJUST TRACKING

If stroller pulls left or right when the front wheel is in jog mode and stroller is on flat terrain, adjust tracking as outlined in the following steps.

▲ WARNING Do not roll test with a child or any occupant in the stroller.

1. Empty Stroller

Remove contents from low boy cargo basket and pockets.

2. Check Tire Pressure

3. Set Stroller to Jog Mode

Slide swivel knob to right. Knob will slide into downward position. Rotate fork/wheel until it “snaps” into forward position. See Choose Walk or Jog Mode section.

4. Place Stroller On Level Ground

Find a stretch of level ground about 16 feet long.



5. Align Rear Wheel Axles

Align stroller so rear wheel axles are perpendicular to a straight line.

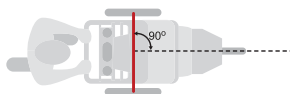

6. Test Alignment

Push stroller straight forward and release to see if stroller veers right or left. Repeat push test several times.

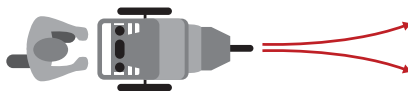

If stroller consistently pulls to left or right, proceed to Fine Tune Tracking.

FINE TUNE TRACKING

If Stroller Pulls LEFT

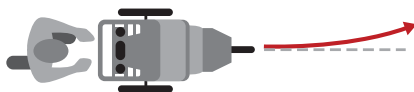

If your stroller pulls LEFT, turn tracking knob counterclockwise up to one half turn.

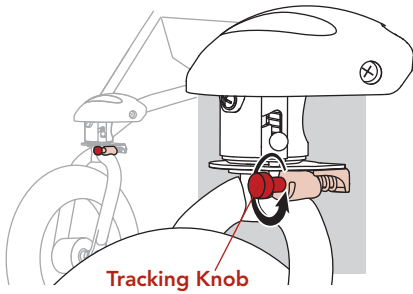

If Stroller Pulls RIGHT

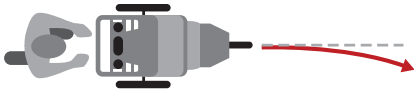

If your stroller pulls RIGHT, turn tracking knob clockwise up to one half turn.

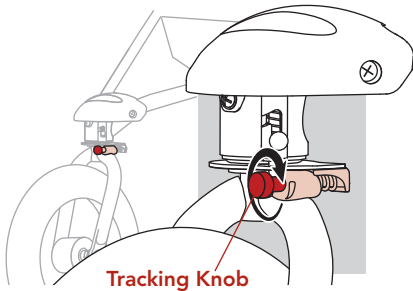

REPEAT roll test and adjust as needed until stroller rolls straight.

SELECT SHOCK SETTING

1. Remove Children From Seat

2. Set Shock Setting To Position 2

Depress shock release knob and simultaneously pull toward back of stroller, sliding knob into position 2. Knob will “snap” into place when in correct position.

REPEAT on opposite side.

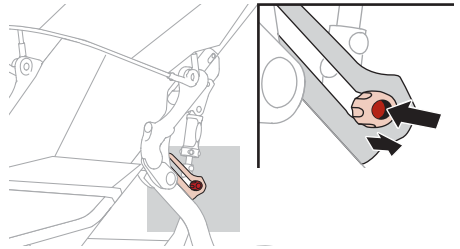

Position 1: Total combined occupant weight 50 pounds

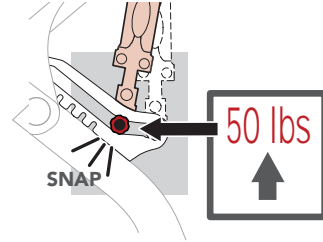

Position 2: Total combined occupant weight 51 to 100 pounds

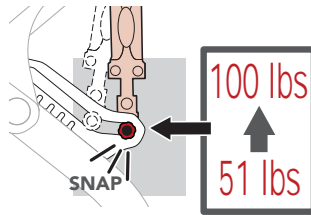

NOTE: Every time stroller is folded, stroller shocks default to 50 lb position.

SETTING PARKING BRAKE

The parking brake prevents the stroller from moving while loading and unloading. The parking brake is not designed as a stopping brake.

▲ WARNING The parking brake is not designed as a stopping brake. The brake should not be used to slow or stop the stroller because doing so could cause the stroller to stop abruptly, resulting in loss of control.

▲ WARNING Do not park on inclines. The parking brake is intended to park the stroller on flat surfaces only. Parking on inclines may result in tip over or runaway stroller.

To set the parking brake, press the brake bar down into the locked position with your foot on the red foot pedal – making sure the locking pin fully engages the locking disk.

LOCKED POSITION

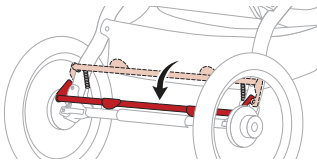

To ensure the brake is set properly, attempt to roll the stroller fore and aft after setting the brake. If the stroller will not roll, the brake is set properly.

To release the parking brake, lift up on the red foot pedal with your foot until the brake bar springs up into the fully unlocked position.

UNLOCKED POSITION

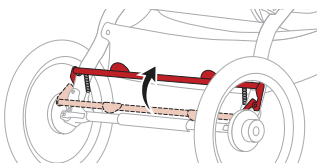

SECURE CHILD IN SEAT

▲ WARNING The maximum weight capacity of the stroller is 100 lbs (45 kg) (occupants plus luggage weight). Maximum occupant height is 44 inches or (112 cm). Do not exceed the maximum weight or height, as stroller will become unstable.

▲ WARNING Avoid serious injury from falling or sliding out. Always use seat harnesses.

▲ WARNING Never leave children in the stroller unattended with or without the parking brake set.

1. Set Parking Brake

Rotate parking brake bar down into locked position.

NOTE: Rear wheels should not rotate when parking brake is set.

2. Place Child In Seat

Slip one shoulder strap over each shoulder. Position crotch strap between legs.

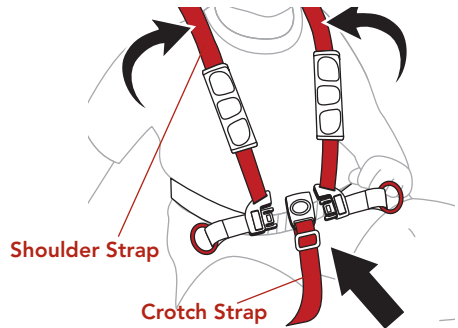

3. Fasten Shoulder Straps

Insert both shoulder strap buckles into crotch strap buckle.

NOTE: Crotch strap should be adjusted to have a snug fit.

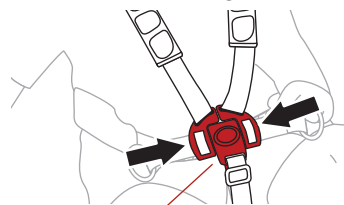

Crotch Strap Buckle

4. Adjust Shoulder Strap Height

Adjust height of shoulder strap to fit just above child shoulder height.

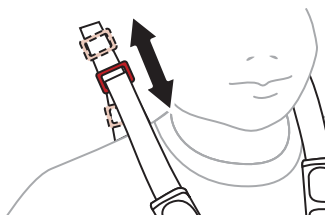

5. Adjust Shoulder Straps

Open Velcro pads. Slide buckle up or down to adjust straps. Seat harness should fit snug and be comfortable.

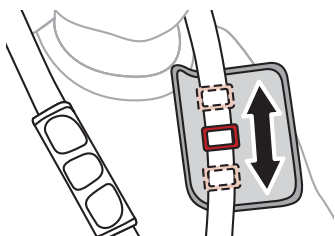

6. Tighten Lap Straps

Adjust lap straps to fit snug and be comfortable.

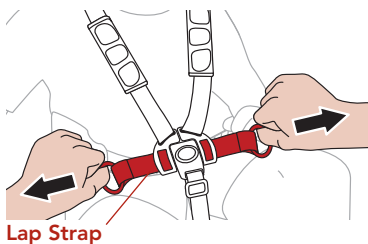

ATTACH WRIST STRAP

The wrist strap is designed to help prevent the stroller from rolling away should you lose your grip on the stroller. When using the stroller, make sure the strap is securely looped over your wrist.

▲ WARNING Failure to attach wrist strap can result in damage or injury.

Secure Wrist Strap

Slip loop of strap securely onto wrist.

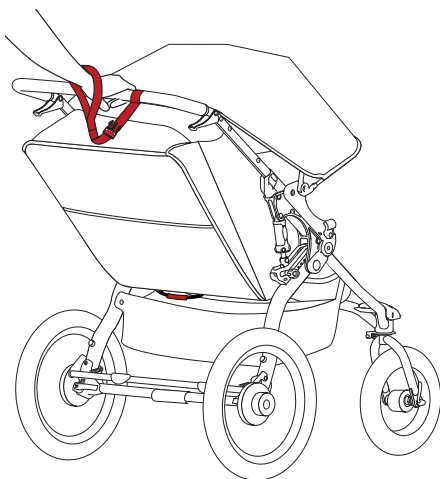

RECLINE SEAT

▲ WARNING Set parking brake before making any seat adjustments.

1. Recline Seat

Pull up on seat recline buckle to loosen recline straps.

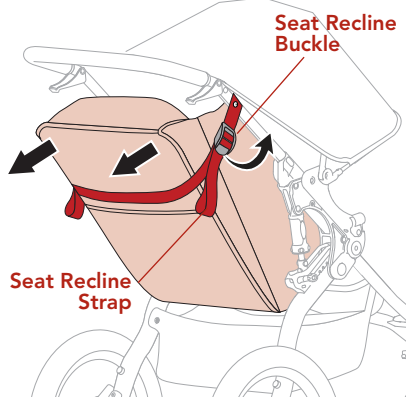

2. Return To Upright Position

To raise seat, lift seat back with one hand and pull recline strap down with other hand.

REPEAT on opposite side.

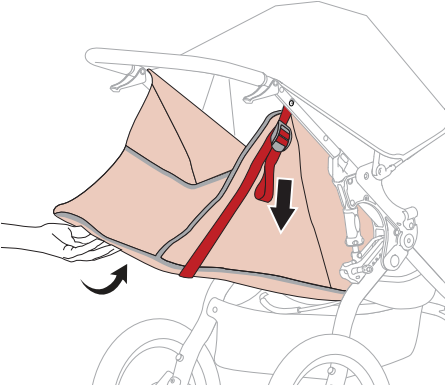

▲ WARNING When seat and/or seats are fully reclined, backward tip over is more likely to occur and may result in an accident or injury, as seats and/or passengers may contact ground before handlebar.

▲ WARNING Always jog with the stroller seats in the fully upright position. Jogging with the seat/ seats in reclined positions may result in a loss of stability.

POSITION CANOPY

1. Extend Canopy

Rotate canopy away from handlebar for additional shade.

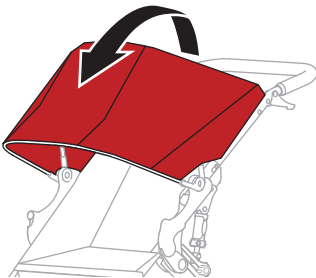

2. Retract Canopy

Push canopy toward handlebar.

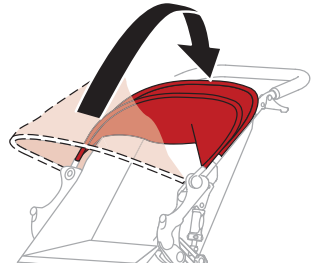

ACCESSORY ADAPTER

This BOB stroller is equipped with an accessory adapter providing easy attachment for BOB Stroller accessories like the Snack Tray or Infant Car Seat Adapter.

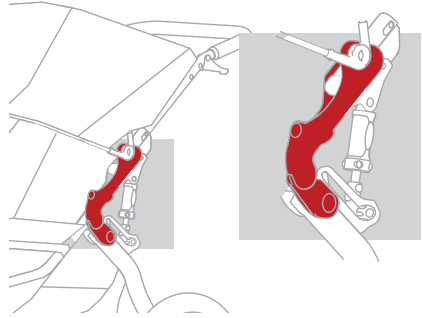

Attaching BOB accessories is simple and easy with this push button, lock and release design. The accessory adapter also allows for many accessories to remain attached when the stroller is folded. See Stroller Accessories section of this manual for more information on all available accessories.

CARE AND MAINTENANCE

▲ WARNING Check tire pressure before every use.

CLEANING

The fabric has a stain resistant treatment that makes most cleanups easy. Use a sponge with a solution of mild soap and cold water (maximum

temperature of 100 deg. F / 38 deg. C). Rinse thoroughly with clean water to remove soap then air dry. Do not use detergent.

REGULAR INSPECTIONS

We recommend inspecting your stroller before every use. Verify tire pressure. Verify all screws, attachment points and fasteners are tight. Check all wheels to be sure they are securely clamped. Check for tears or excessive wear in the fabric. We recommend you take your stroller to a designated BOB dealer for periodic inspection and service.

STORAGE

It is best to store your stroller indoors when it is not in use. This will prolong its attractive appearance. Extended exposure to the sun's ultraviolet rays can fade and damage the fabric, tires, and plastic parts.

CARGO

The stroller is equipped with two small seat pockets for your child, a seat back pocket and a low boy cargo basket under the stroller.

▲ WARNING Adding weight to the seat back changes the center of gravity of the stroller, and increases the possibility that it will tip over backwards, resulting in injury. For this reason, loads in the seat back pockets should never exceed two pounds (1 kg) and maximum weight capacity for low boy cargo basket is 10 lbs (4.5 kg).

Although the seat back is padded, it is important to remember that this is what your child leans against.

▲ WARNING Do not place sharp objects in the seat back pockets. Leaning against sharp objects in the seat back pocket can result in injury to occupants.



STROLLER ACCESSORIES

BOB offers a complete line of accessories for your Revolution stroller. Visit our website for full details.

HANDLEBAR CONSOLE

Place snacks, water and cell phone conveniently at your fingertips. The Handlebar Console attaches easily and securely. Includes two water bottle holders and a storage pocket.

WARM FUZZY

Add warmth and comfort to your child's stroll. The Warm Fuzzy is a padded fleece seat liner that inserts into any BOB Stroller seat.

WEATHER SHIELD

The Weather Shield's water resistant design helps to protect your child from rain and wind while still allowing a view of the world.

INFANT CAR SEAT ADAPTER

The BOB Infant Car Seat Adapter allows you to easily attach leading infant car seat models to a BOB Stroller utilizing the BOB Accessory Adapter feature.

SUN SHIELD

The Sun Shield's specially designed mesh screen reduces the sun's harmful ultraviolet UVA/UVB rays and helps to provide a barrier to wind and flying insects.

DIAPER BAG

Clips directly to all BOB single and Duallie® strollers. Shoulder strap, changing pad and removable waterproof insert included.

SNACK TRAY

The Snack Tray easily inserts into any BOB Stroller utilizing the BOB Accessory Adapter feature, placing snacks and sippy cups at your child's fingertips.

LIMITED WARRANTY

BOB Trailers Inc. takes pride in its workmanship and strives to manufacture the best products possible. Therefore, we warranty our strollers against defects in material and workmanship for the periods and parts set forth below, subject to the conditions listed below. Since no product is indestructible, it does not cover defects attributable to or resulting from normal wear, abuse or alteration.

FRAME AND COMPONENTS

The frame is warranted for five years. Components and fabric are warranted for one year. Warranty is only valid for the original purchaser. Proof of purchase is required to exercise this warranty. Labor and freight charges are not included.

NORMAL WEAR

Normal wear, corrosion, neglect, abuse, accidents, improper assembly or maintenance, or the installation of parts or accessories not compatible with the original intended use of the stroller, as sold, are not covered by this warranty. Tires and tubes are not covered under the limited warranty.

WARRANTY CLAIMS

Warranty claims must be made through an authorized dealer. This warranty is limited to the repair or replacement of the defective part. BOB shall in no event be responsible for consequential or special damages.

This limited warranty is the only express or implied warranty applicable to BOB. Any implied warranties, including warranties of merchantability and fitness shall be limited in scope and duration in accordance with this limited warranty.

PRODUCT REGISTRATION

Visit www.bobgear.com/register to register your stroller.

SERIAL NUMBER

Open the stroller. From the back of stroller, look on the inside of the right swing arm.

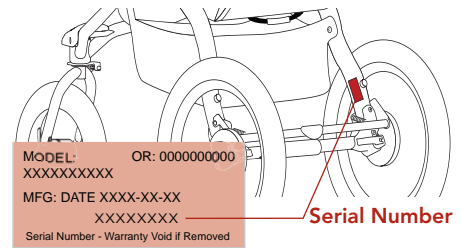

Copyright © 2010 BOB Trailers, Inc.
BOB TRAILERS, Inc.
(800) 893-2447
www.bobgear.com

